

PNY™

MOTHERBOARD

MBM630I7150

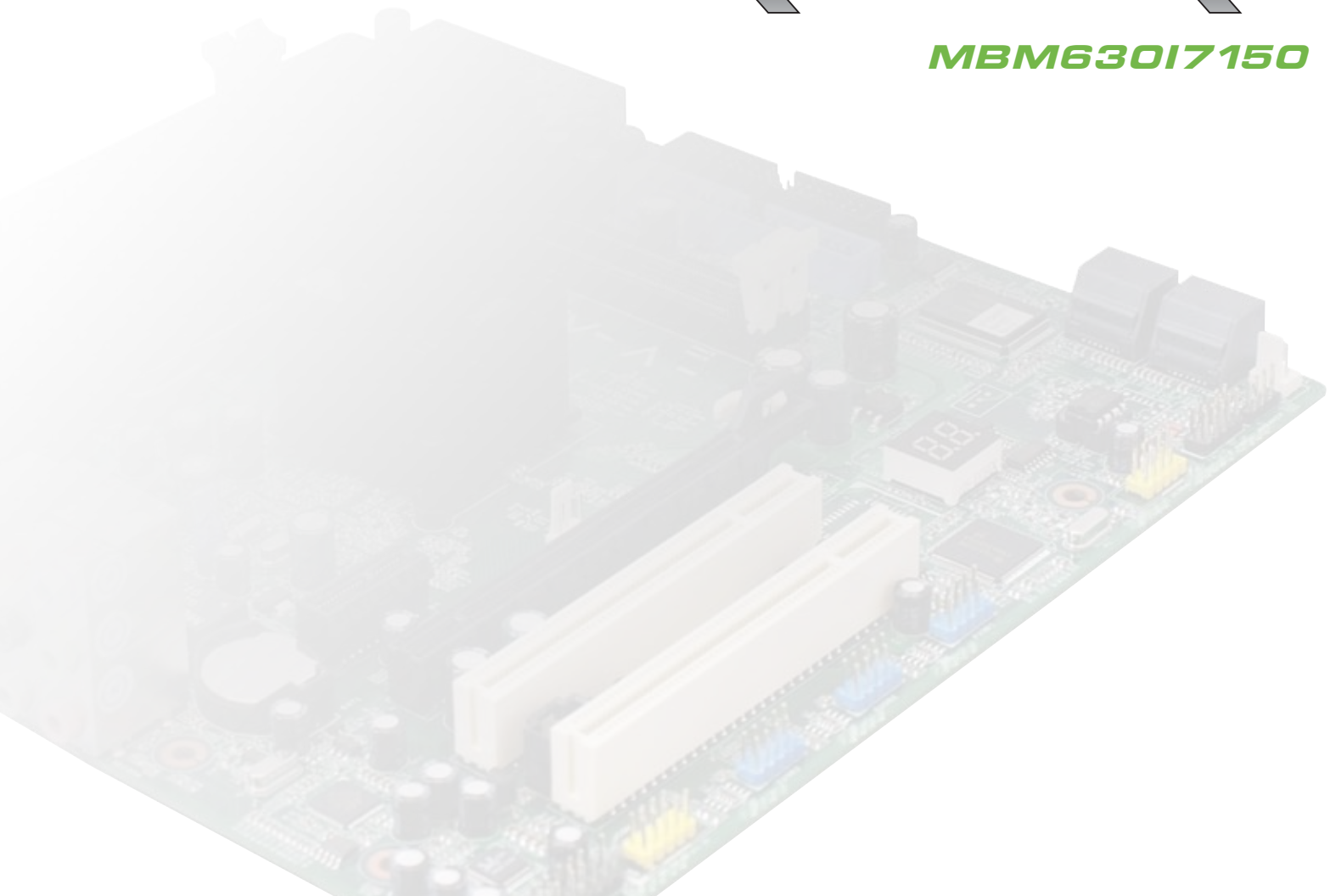

Disclaimer

The intellectual property of this manual belongs to our company. The ownership of all of the products, including accessories and software etc. belong to our company. No one is permitted to copy, change, or translate without our written permission.

We compiled this manual based on our careful attitude, but we can not guarantee the accuracy of the contents. This manual is purely technical documentation, without any hint or other meanings, and we won't commit users' misunderstanding of the typesetting error.

Our products are in continuous improvement and updating, Therefore, we retain the right that we won't give notice to the users in future.

Copyright

All of the trademark in this manual belong to their own registered company.

All of the products name is only for identification, its title belongs to its manufacturer or brand owner.

Table of Contents

Chapter 1 Introduction	3
1.1 Package Checklist	3
1.2 Specifications	4
1.3 Mainboard Layout	5
1.4 Connecting Rear Panel I/O Devices	6
Chapter 2 Hardware Setup	7
2.1 Choosing a Computer Chassis	7
2.2 Installing Mainboard	7
2.3 Installation of the CPU and CPU Cooler.....	8
2.3.1 Installation of the CPU	8
2.3.2 Installation of the CPU Cooler	9
2.4 Installation of Memory Modules.....	9
2.5 Connecting Peripheral Devices.....	10
2.5.1 Floppy and IDE Disk Drive Connectors	10
2.5.2 Serial ATA Connectors	10
2.5.3 PCI and PCI Express slots	10
Chapter 3 Jumpers & Headers Setup	11
3.1 Checking Jumper Settings	11
3.2 CMOS Memory Clearing Header	11
3.3 Keyboard Power Function	11
3.4 FAN Power Connectors	12
3.5 Front Panel Switches & Indicators Headers	12
3.6 Additional USB Port Headers	13
3.7 Front Panel Audio Connection Header.....	13
3.8 Internal Audio Connectors	14
3.9 S/PDIF Output Connection Header.....	14
3.10 Serial Port Header.....	15
3.11 ATX Power Input Connectors	15
Chapter 4 BIOS Setup Utility	16
4.1 About BIOS Setup	16
4.2 To Run BIOS Setup	16
4.3 About CMOS.....	16
4.4 The POST (Power On Self Test).....	16
4.5 BIOS Setup — CMOS Setup Utility.....	17
4.5.1 CMOS Setup Utility	17
4.5.2 Control Keys	18
4.5.3 Standard CMOS Features	19
4.5.4 Advanced BIOS Features	21
4.5.5 Advanced Chipset Features	23
4.5.6 Integrated Peripherals	24
4.5.7 Power Management Setup	26
4□	
4.5.9 PC Health Status	29
4.5.10 Frequency/Voltage Control	29
4.5.11 Load Fail-Safe Defaults	31
4.5.12 Load Optimized Defaults	31
4.5.13 Set Supervisor/User Password	31
4.5.14 Save & Exit Setup	32
4.5.15 Exit Without Saving	32

Chapter 1 Introduction

1.1 Package Checklist

Thank you for choosing our product.

Please check the following packing and accessories, if there is any broken or part missing, please contact with your franchiser.

- HDD Cable X 1
- Serial ATA Cable X 1
- Rear I/O Panel X 1
- User's Manual X 1
- Driver/Utility CD X 1
- FDD Cable X 1

The items listed above are for reference only, and are subject to change without notice.

1.2 Specifications

CPU	<ul style="list-style-type: none"> - LGA775 socket for Intel® Core™2 Quad/Core™2 Duo/Pentium® Dual Core/Pentium® D/Pentium® 4/Celeron® D/Celeron® Processors - FSB 1333MHz/1066MHz/800MHz/533MHz (MCP73V support FSB 1066MHz/800MHz/533MHz only) - Hyper Threading Technology
Chipset	- Based on nVIDIA MCP73U/PV/V/D chipset
VGA	<ul style="list-style-type: none"> - Integrated nVIDIA Geforce 7150 graphics (for MCP73U chipset only) - Integrated nVIDIA Geforce 7100 graphics (for MCP73PV chipset only) - Integrated nVIDIA Geforce 7050 graphics (for MCP73V chipset only)
Main Memory	<ul style="list-style-type: none"> - 2 X 240-pin DIMM slots support - Maximum memory capacity up to 4 GB - Supports DDR2 800MHz/677MHz/533MHz (MCP73V support 677MHz/533MHz only)
BIOS	<ul style="list-style-type: none"> - Supports Plug&Play - Supports STR Function (Optional) - Supports Advanced Power Management ACPI - CPU temperature, Fan speed, System Voltage monitoring
Integrate Ports	<ul style="list-style-type: none"> - 1 X PS/2 Keyboard port - 1 X PS/2 Mouse port - 1 X VGA port (MCP73D not support) - 1 X DVI port (MCP73D/V not support) - 1 X HDMI port (MCP73D/V not support) - 1 X RJ45 port - 1 X SPDIF IN/OUT (MCP73V support S/PDIF OUT only) - 1 X Debug LED (Optional) - 10 X USB 2.0 ports, USB 1.1 is compliant (MCP73V integrated 8 X USB 2.0 ports) - 1 X 1394 port (Optional) - 4 X SATA II 3Gb/s support SATA RAID 0,1,0+1,5 - 1 X IDE connector, 2 X IDE devices could be connected, support ATA 66/100/133 - 1 X Floppy Drive, supports 360K/720K/1.2M/1.44M/2.88M floppy disk
Sound	<ul style="list-style-type: none"> - Onboard 6-channel/8-channel HD Audio Codec (Optional) - Supports 16 bit Audio Codec - Positioning Audio Support A3D, I3DL2 - Front Panel Jumper, provides stereo MIC port on front panel
Onboard LAN	-Onboard 10/100/1000Mbps compatible LAN (Optional)
Expansion Slots	<ul style="list-style-type: none"> - 1 X PCI Express x16 slot - 1 X PCI Express x1 slot - 2 X PCI slots - Support PCI Bus interface v2.3 compliant
Form Factor	- Micro-ATX

1.3 Mainboard Layout(MCP73V 1.0)

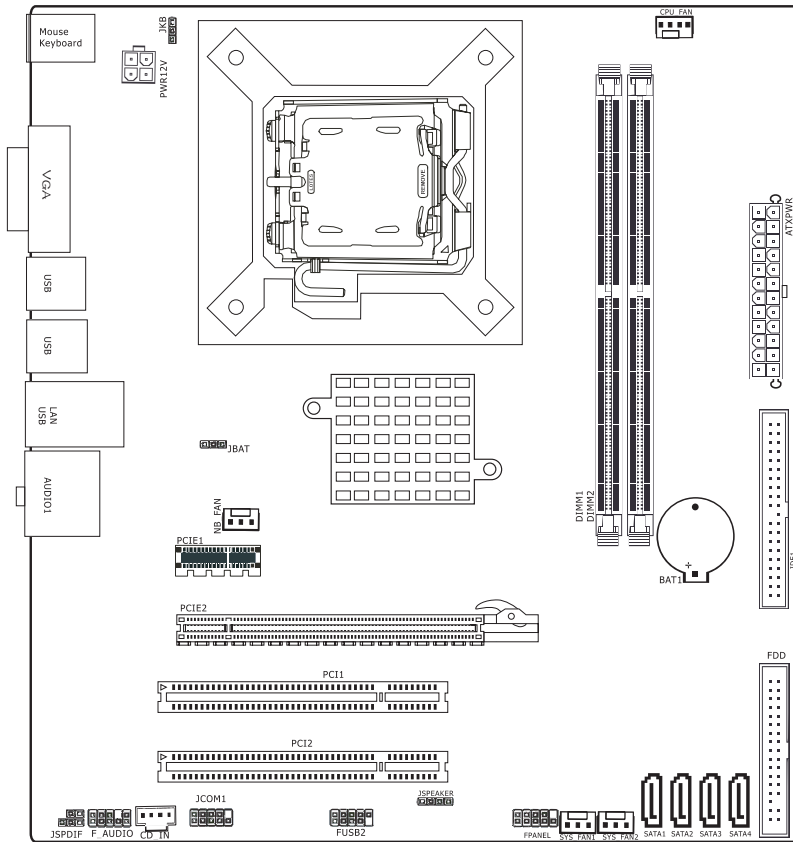

(This picture is only for reference)

1.3 Mainboard Layout (MCP73PV/U)

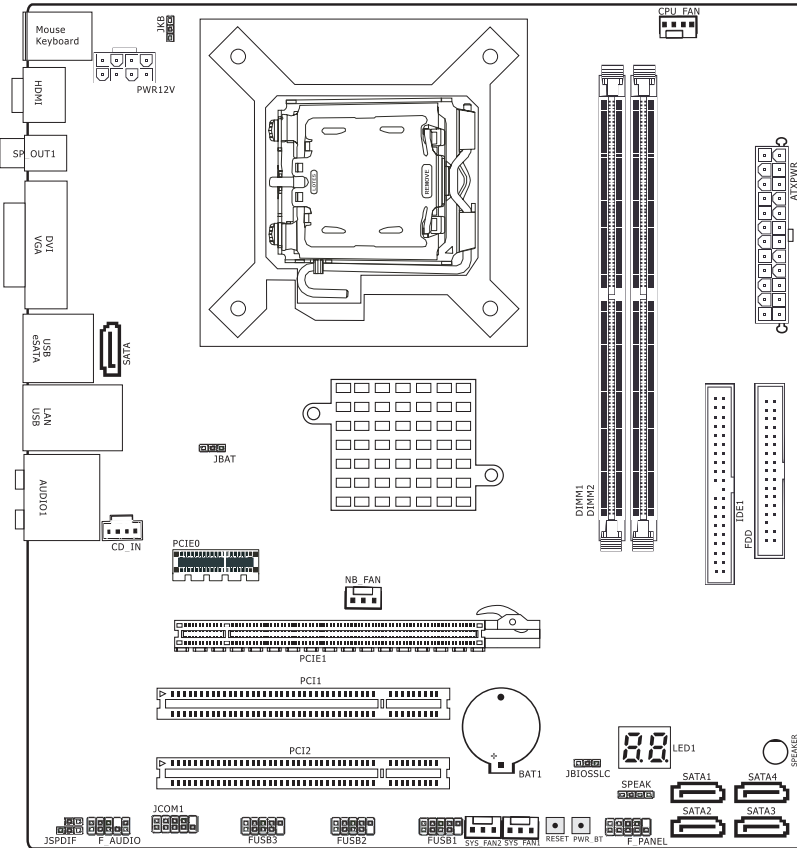

(This picture is only for reference)

1.4 Connecting Rear Panel I/O Devices

The rear I/O part of the mainboard provides the following I/O ports:

---MCP73PV/U I/O Panel

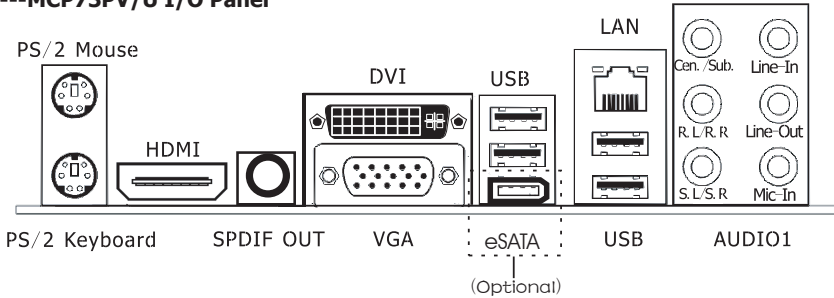

Output Function Remark: VGA connector have display if the HDMI or DVI be connected, and HDMI or DVI have the same display at the same time; if HDMI and DVI be connected at the same time, but don't connect VGA connector, the HDMI will display firstly, but DVI cannot display.

---MCP73V I/O Panel

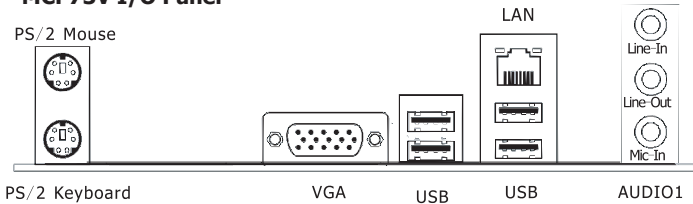

- **PS/2 Mouse:** Connect to PS/2 mouse.
- **PS/2 Keyboard:** Connect to PS/2 keyboard.
- **HDMI:** Connects to multimedia devices of HDMI protocol. (MCP73D/V not support)
- **SPDIF OUT:** This connector provides an S/PDIF-Out connection through optical fiber to digital multimedia devices.
- **VGA:** Connect to monitor input. (MCP73D not support)
- **DVI:** Connect to monitor input. (MCP73D/V not support)
- **LAN:** Connect to Local Area Network.
- **USB:** Connect to USB devices such as scanner, digital speakers, monitor, mouse, keyboard, hub, digital camera, joystick etc.
- **eSATA:** Connect to peripheral SATA devices. The peripheral SATA devices must connect inside SATA connectors. (Optional)
- **AUDIO1:**
 - Cen./Sub. (Center / Subwoofer): Connect to the center and subwoofer channel in the 7.1 channel audio system.
 - R.L./R.R. (Rear Left / Rear Right): Connect to the rear left and rear right channel in the 7.1 channel audio system.
 - S.L./S.R. (Surround Left / Surround Right): Connect to the surround left and surround right channel in the 7.1 channel audio system.
 - Line-In: Connect to the line out from external audio sources.
 - Line-Out: Connect to the front left and front right channel in the 7.1-channel or regular 2-channel audio system.
 - Mic-In: Connect to the plug from external microphone.

Chapter 2 Hardware Setup

2.1 Choosing a Computer Chassis

- Choose a chassis big enough to install this mainboard.
- As some features for this mainboard are implemented by cabling connectors on the mainboard to indicators and switches or buttons on the chassis, make sure your chassis supports all the features required.
- If there is possibility of adopting some more hard drives, make sure your chassis has sufficient power and space for them.
- Most chassis have alternatives for I/O shield located at the rear panel. Make sure the I/O shield of the chassis matches the I/O port configuration of this mainboard. You can find an I/O shield specifically designed for this mainboard in its package.

2.2 Installing Mainboard

Most computer chassis have a base with many mounting holes to allow the mainboard to be securely attached, and at the same time, prevent the system from short circuits. There are two ways to attach the mainboard to the chassis base: (1) with studs, or (2) with spacers.

Basically, the best way to attach the board is with studs. Only if you are unable to do this should you attach the board with spacers. Line up the holes on the board with the mounting holes on the chassis. If the holes line up and there are screw holes, you can attach the board with studs. If the holes line up and there are only slots, you can only attach with spacers. Take the tip of the spacers and insert them into the slots.

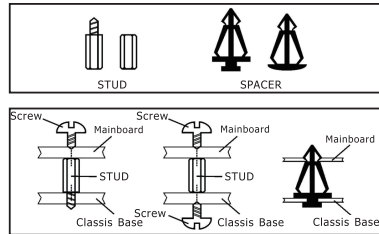

After doing this to all the slots, you can slide the board into position aligned with slots. After the board has been positioned, make sure everything is OK before putting the chassis back on.

 Always power off the computer and unplug the AC power cord before adding or removing any peripheral or component. Failing to do so may cause severe damage to your mainboard and/or peripherals. Plug in the AC power cord only after you have carefully checked everything.

To install this mainboard:

1. Locate all the screw holes on the mainboard and the chassis base.
2. Place all the studs or spacers needed on the chassis base and have them tightened.
3. Face the mainboard's I/O ports toward the chassis's rear panel.
4. Line up all the mainboard's screw holes with those studs or spacers on the chassis.
5. Install the mainboard with screws and have them tightened.

 To prevent shorting the PCB circuit, please REMOVE the metal studs or spacers if they are already fastened on the chassis base and are without mounting-holes on the mainboard to align with.

2.3 Installation of the CPU and CPU Cooler

Before installing the CPU, please comply with the following conditions:

1. Please make sure that the mainboard supports the CPU.
2. Please take note of the one indented corner of the CPU. If you install the CPU in the wrong direction, the CPU will not insert properly. If this occurs, please change the insert direction of the CPU.
3. Please add an even layer of heat sink paste between the CPU and CPU cooler.
4. Please make sure the CPU cooler is installed on the CPU prior to system use, otherwise overheating and permanent damage of the CPU may occur.
5. Please set the CPU host frequency in accordance with the processor specifications. It is not recommended that the system bus frequency be set beyond hardware specifications since it does not meet the required standards for the peripherals. If you wish to set the frequency beyond the proper specifications, please do so according to your hardware specifications including the CPU, graphics card, memory, hard drive, etc.

2.3.1 Installation of the CPU

1. Open the socket lever by pushing the lever down and away from the socket (see Figure 1, 1 and 2).

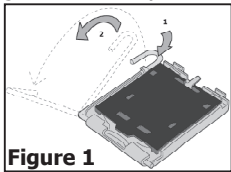

Figure 1

2. Lift the load plate. Do not touch the socket contacts (see Figure 2, 3 and 4)

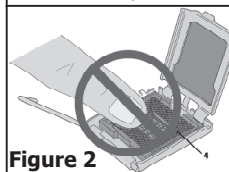
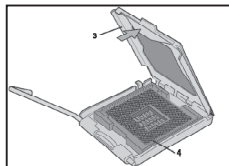

Figure 2

3. Remove the plastic protective socket cover from the load plate (see Figure 3, 5). Do not discard the protective socket cover. Always replace the socket cover if the processor is removed from the socket.

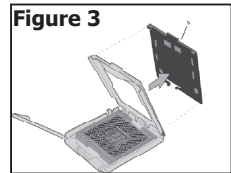

Figure 3

4. Remove the processor from the protective processor cover. Hold the processor only at the edges, being careful not to touch the bottom of the processor (see Figure 4). Do not discard the protective processor cover. Always replace the processor back to the package if the processor is removed from the socket.

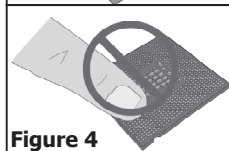
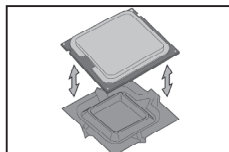

Figure 4

5. Hold the processor with your thumb and index fingers oriented as shown in Figure 5. Make sure fingers align to the socket cutouts (see Figure 5, 6). Align notches (see Figure 5, 7) with the socket see (Figure 5, 8). Lower the processor straight down without tilting or sliding the processor in the socket.

6. Pressing down on the load plate (Figure 6, 9) close and engage the socket lever (Figure 6, 10).

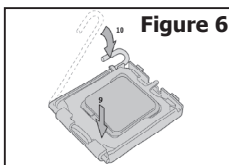

Figure 6

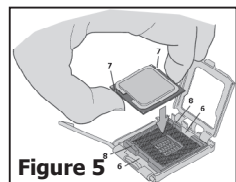

Figure 5

2.3.2 Installation of the CPU Cooler

For proper installation, please kindly refer to the instruction manuals of your CPU Cooler.

2.4 Installation of Memory Modules

This mainboard provides two 240-pin DDRII (Double Data Rate) DIMM slots.



Static electricity can damage the electronic components of the computer or optional boards. Before starting these procedures, ensure that you are discharged of static electricity by touching a grounded metal object briefly.

To install system memory:

1. Power off the computer and unplug the AC power cord before installing or removing memory modules.
2. Locate the DIMM slot on the board.
3. Hold two edges of the DIMM module carefully, keep away from touching its connectors.
4. Align the notch key on the module with the rib on the slot.
5. Firmly press the module into the slots until the ejector tabs at both sides of the slot automatically snap into the mounting notch. Do not force the DIMM module in with extra force as the DIMM module only fits in one direction.
6. To remove the DIMM modules, push the two ejector tabs on the slot outward simultaneously, and then pull out the DIMM module.

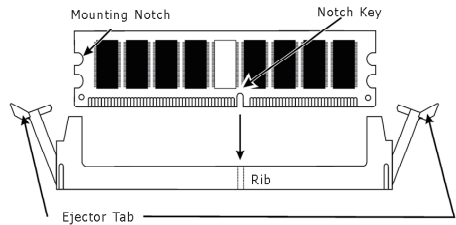

2.5 Connecting Peripheral Devices

2.5.1 Floppy and IDE Disk Drive Connectors

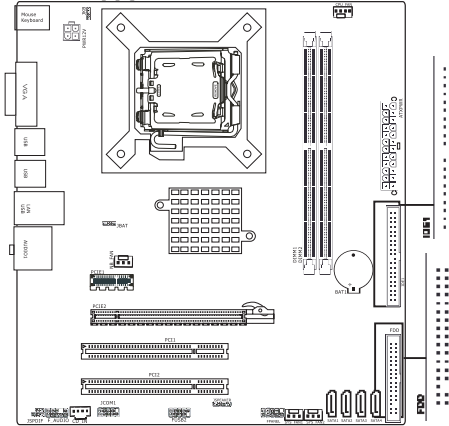

Each of the IDE port connects up to two IDE drives at Ultra ATA 66/100/133 mode by one 40-pin, 80-conductor, and 3-conductor Ultra ATA/66 ribbon cables. Connect the single end (blue connector) at the longer length of ribbon cable to the IDE port of this board, the other two ends (gray and black connector) at the shorter length of the ribbon cable to the connectors of your hard drives.

⚠ Make sure to configure the "Master" and "Slave" relation before connecting two drives by one single ribbon cable. The red line on the ribbon cable must be aligned with pin-1 on both the IDE port and the hard-drive connector.

The FDD connector connects up to two floppy drives with a 34-wire, 2-conductor floppy cable. Connect the single end at the longer length of ribbon cable to the FDD on the board, the two connectors on the other end to the floppy disk drives connector. Generally you need only one floppy disk drive in your system.

⚠ The red line on the ribbon cable must be aligned with pin-1 on both the FDD port and the floppy connector.

2.5.2 Serial ATA Connectors

Each SATA connector serves as one single channel to connect one SATA device by SATA cable.

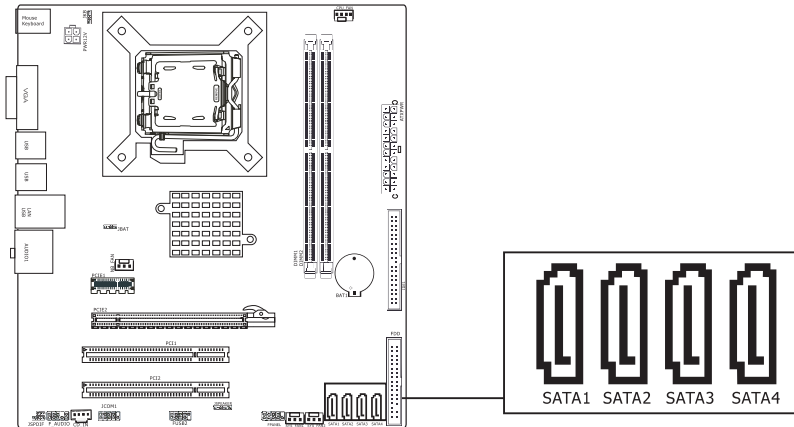

2.5.3 PCI and PCI Express slots

- Install PCI Express X16 graphics card into slot "PCIE2".
- Install PCI Express X1 card into slot "PCIE1".
- Install PCI card into slots "PCI1" or "PCI2".

Chapter 3 Jumpers & Headers Setup

3.1 Checking Jumper Settings

- For a 2-pin jumper, plug the jumper cap on both pins will make it CLOSE (SHORT). Remove the jumper cap, or plug it on either pin (reserved for future use) will leave it at OPEN position.
- For 3-pin jumper, pin 1~2 or pin 2~3 can be shorted by plugging the jumper cap in.

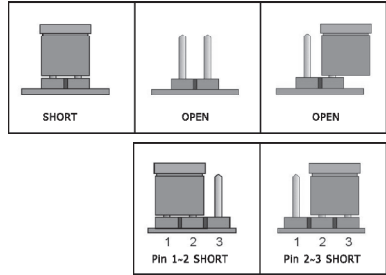

How to identify the PIN1 jumpers?
Please check the mainboard carefully, the PIN1 is marked by "1" or white thick line.

3.2 CMOS Memory Clearing Header

The time to clear the CMOS memory occurs when (a) the CMOS data becomes corrupted, (b) you forgot the supervisor or user password preset in the BIOS menu, (c) you are unable to boot-up the system because the CPU ratio/clock was incorrectly set in the BIOS menu, or (d) whenever there is modification on the CPU or memory modules.

This header uses a jumper cap to clear the CMOS memory and have it reconfigured to the default values stored in BIOS.

- Pins 1 and 2 shorted (Default): Normal operation.
- Pins 2 and 3 shorted: Clear CMOS memory.

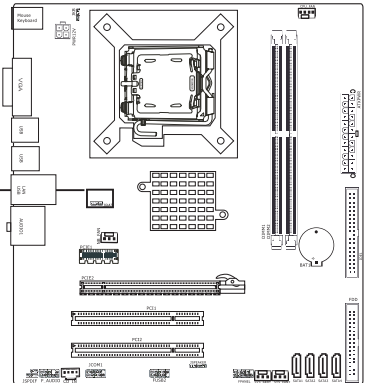
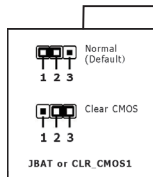

To clear the CMOS memory and load in the default values:

1. Power off the system.
2. Set pin 2 and pin 3 shorted by the jumper cap. Wait for a few seconds. Set the jumper cap back to its default settings --- pin 1 and pin 2 shorted.
3. Power on the system.
4. For incorrect CPU ratio/clock settings in the BIOS, press key to enter the BIOS setup menu right after powering on system.
5. Set the CPU operating speed back to its default or an appropriate value.
6. Save and exit the BIOS setup menu.

3.3 Keyboard Power Function(JKB)

Pin 1-2 short: Disabled power on by keyboard
 Pin 2-3 short: Support power on by keyboard

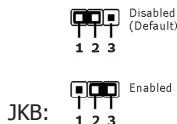

3.4 FAN Power Connectors

These connectors each provide power to the cooling fans installed in your system.

CPU_FAN: CPU Fan Power Connector
SYS_FAN1/SYS_FAN2: System Fan Power Connector
NB_FAN: System Fan Power Connector

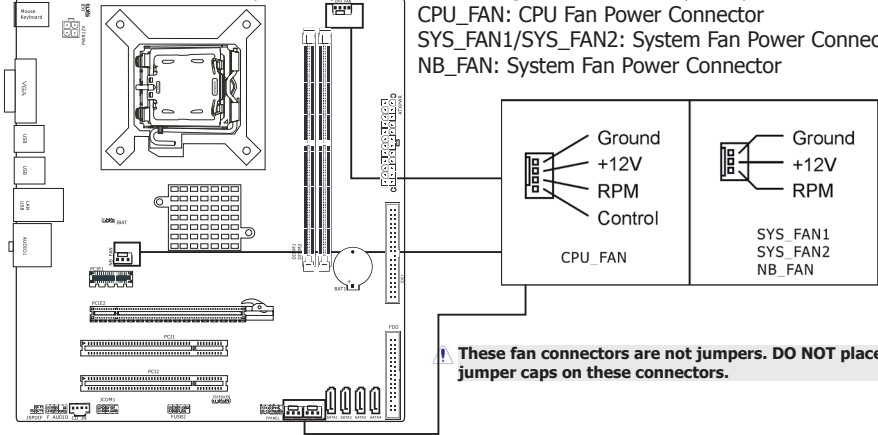

3.5 Front Panel Switches & Indicators Headers

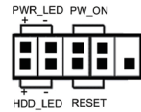
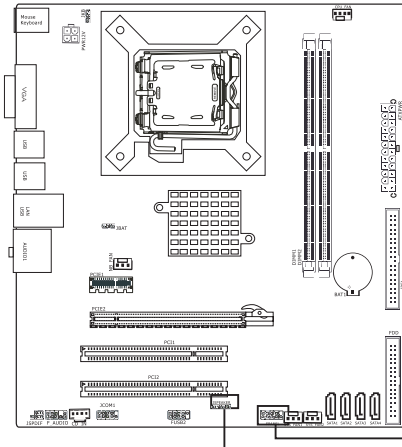

Figure 1: Reference for 9 pin F_PANEL.

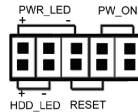

Figure 2: Reference for 10 pin F_PANEL.



HDD_LED (Hard Driver LED Header)

Connect the HDD LED cable to these PINs, in order to see the HDD status

RESET (Reset Control)

This connector connects to the case-mounted reset switch for rebooting your computer without having to turn off your power switch. This is a preferred method of rebooting in order to prolong the life of the system's power supply.

PWR-ON (Power Button)

This connector connects to the case-mounted power switch to power ON/OFF the system.

SPEAKER (Speaker)

This 4-pin connector connects to the case-mounted speaker. You should follow the instruction of the speaker cable.

3.6 Additional USB Port Headers

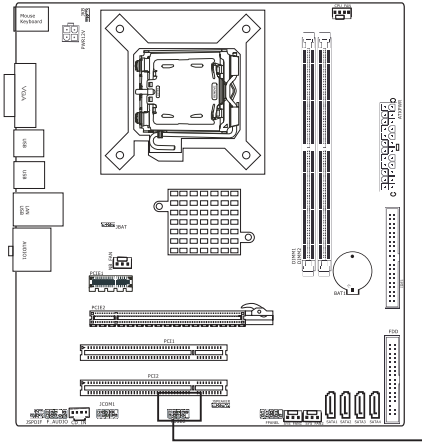

Pin	Pin Assignment	Pin	Pin Assignment
1	VCC	2	VCC
3	Data 0-	4	Data 1-
5	Data 0+	6	Data 1+
7	Ground	8	Ground
		10	NC

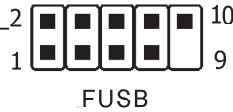

3.7 Front Panel Audio Connection Header

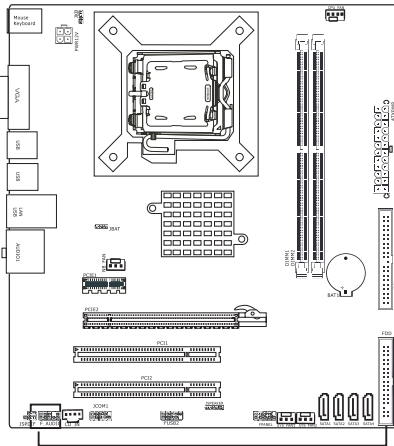

HD Audio:

Pin No.	Definition
1	MIC2_L
2	GND
3	MIC2_R
4	-ACZ_DET
5	LINE2_R
6	FSENSE1
7	FAUDIO_JD
8	No Pin
9	LINE2_L
10	FSENSE2

AC'97 Audio:

Pin No.	Definition
1	MIC
2	GND
3	MIC Power
4	NC
5	Line Out (R)
6	NC
7	NC
8	No Pin
9	Line Out (L)
10	NC



3.8 Internal Audio Connectors

Connect CD-ROM or DVD-ROM audio out to the connector.

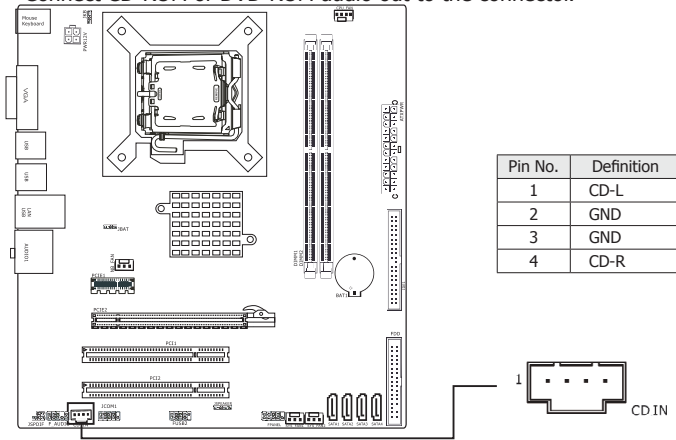

3.9 S/PDIF Output Connection Header (Optional)

S/PDIF (Sony/Philips Digital Interface) is a standard audio transfer file format. It is usually found on digital audio equipment such as a DAT (Digital Audio Tape) machine or audio processing device. It allows the transfer of audio from one file to another without the conversion to and from an analog format, which could degrade the signal quality.

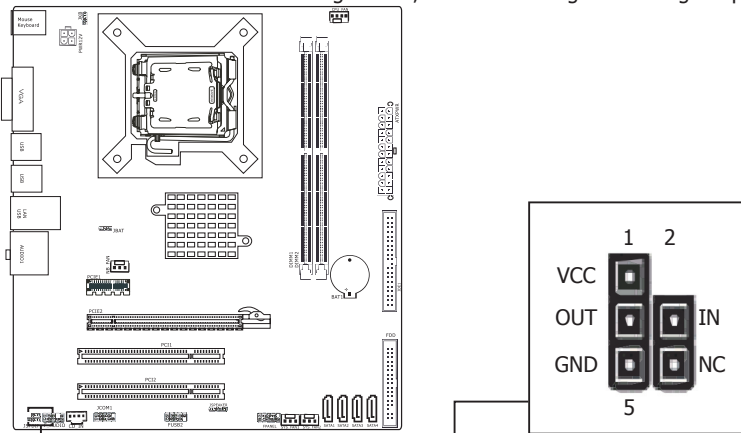

3.10 Serial Port Header (Optional)

This JCOM1 header supports a serial port module.

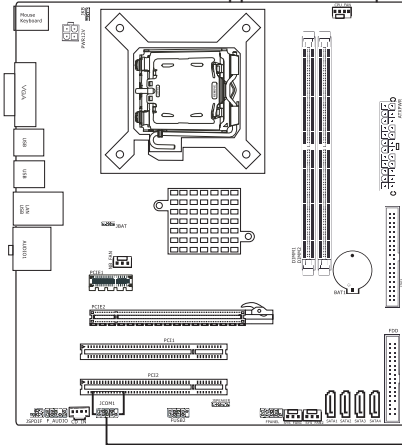

Pin	Pin Assignment	Pin	Pin Assignment
1	DCD	2	RXD
3	TXD	4	DTR
5	GND	6	DSR
7	CTS	8	RTS
9	RI		



3.11 ATX Power Input Connectors

This mainboard provides two power connectors to connect power supplier.

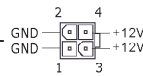
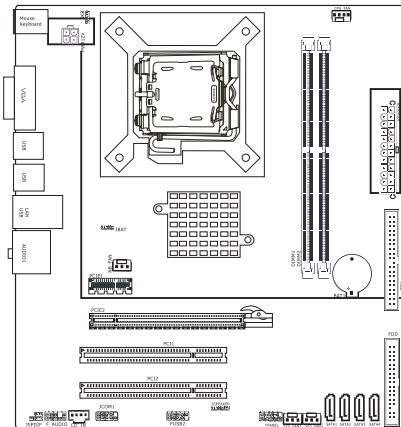

PWR12V

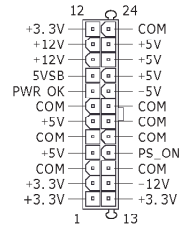

ATXPWR

Chapter 4 BIOS Setup Utility

BIOS stands for Basic Input and Output System. It was once called ROM BIOS when it was stored in a Read-Only Memory (ROM) chip. Now manufacturers would like to store BIOS in EEPROM which means Electrically Erasable Programmable Memory. BIOS used in this series of motherboard is stored in EEPROM, and is the first program to run when you turn on your computer.

BIOS performs the following functions:

1. Initializing and testing hardware in your computer (a process called "POST", for Power On Self Test).
2. Loading and running your operating system.
3. Helping your operating system and application programs manage your PC hardware by means of a set of routines called BIOS Run-Time Service.

4.1 About BIOS Setup

BIOS Setup is an interactive BIOS program that you need to run when:

1. Changing the hardware of your system. (For example: installing a new Hard Disk etc.)
2. Modifying the behavior of your computer. (For example: changing the system time or date, or turning special features on or off etc.)
3. Enhancing your computer's behavior. (For example: speeding up performance by turning on shadowing or cache)

4.2 To Run BIOS Setup

First access BIOS setup menu by pressing key after "POST" is complete (before OS is loaded). BIOS will then display the following message:

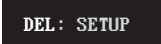

DEL: SETUP

4.3 About CMOS

CMOS is the memory maintained by a battery. CMOS is used to store the BIOS settings you have selected in BIOS Setup. CMOS also maintains the internal clock. Every time you turn on your computer, the BIOS looks into CMOS for the settings you have selected and configures your computer accordingly. If the battery runs out of power, the CMOS data will be lost and POST will issue a "CMOS invalid" or "CMOS checksum invalid" message. If this happens, you have to replace the battery and check and configure the BIOS Setup for the new start.

4.4 The POST (Power On Self Test)

POST is an acronym for Power On Self Test. This program will test all things the BIOS does before the operating system is started. Each of POST routines is assigned a POST code, a unique number which is sent to I/O port 080h before the routine is executed.

4.5 BIOS Setup — CMOS Setup Utility

- ⚠ **In order to increase system stability and performance, our engineering staff is constantly improving the BIOS menu. The BIOS setup screens and descriptions illustrated in this manual are for your reference only, and may not completely match with what you see on your screen.**
- Do not change the BIOS parameters unless you fully understand its function.**

4.5.1 CMOS Setup Utility

After powering up the system, the BIOS message appears on the screen, the memory count begins, and then the following message appears on the screen:

Press DEL to enter SETUP

If this message disappears before you respond, restart the system by pressing <Ctrl> + <Alt>+ keys, or by pressing the Reset button on computer chassis. Only when these two methods should be fail that you restart the system by powering it off and then back on.

After pressing key, the main menu screen appears.

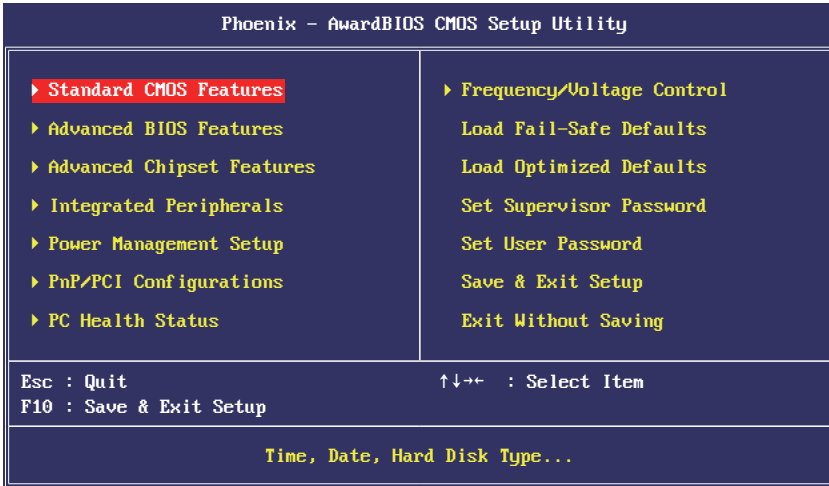

- **Standard CMOS Features**
This setup page includes all the items in standard compatible BIOS.
- **Advanced BIOS Features**
This setup page includes all the items of Award special enhanced features.
- **Advanced Chipset Features**
This setup page includes the Chipset features.
- **Integrated Peripherals**
This setup page includes all onboard peripherals.
- **Power Management Setup**
This setup page includes all the items of Green function features.
- **PnP/PCI Configurations**
This setup page includes all the configurations of PCI & PnP ISA resources.

- **PC Health Status**
This setup page is the System auto detect temperature, voltage, fan, speed.
- **Frequency/Voltage Control**
This setup page is control CPU clock and frequency ratio.
- **Load Fail-Safe Defaults**
Fail-Safe Defaults indicates the value of the system parameters which the system would be in safe configuration.
- **Load Optimized Defaults**
Optimized Defaults indicates the value of the system parameters which the system would be in best performance configuration.
- **Set Supervisor Password**
Change, set, or disable password. It allows you to limit access to the system and Setup, or just to Setup.
- **Set User Password**
Change, set, or disable password. It allows you to limit access to the system.
- **Save & Exit Setup**
Save CMOS value settings to CMOS and exit setup.
- **Exit Without Saving**
Abandon all CMOS value changes and exit setup.

4.5.2 Control Keys

Press F1 to pop up a small help window that describes the appropriate keys to use and the possible selections for the high lighted item.

Please check the following table for the function description of each control key.

Control Key(s)	Function Description
← / →	Move cursor left or right to select Screens
↑ / ↓	Move cursor up or down to select items
+ / - / PU / PD	To Change option for the selected items
<Enter>	To bring up the selected screen
<ESC>	Main Menu - Quit and not save changes into CMOS Status Page Setup Menu and Option Page Setup Menu - Exit current page and return to Main Menu
<F1>	General help
<F2>	Item Help
<F5>	Restore the previous CMOS value from CMOS, only for Option Page Setup Menu
<F6>	Load the fail-safe default CMOS value from BIOS default table
<F7>	Load the Optimized Defaults
<F10>	Save all the CMOS changes

4.5.3 Standard CMOS Features

Phoenix - AwardBIOS CMOS Setup Utility
Standard CMOS Features

Date (mm:dd:yy)	Thu, Aug 23 2007	Item Help
Time (hh:mm:ss)	13 : 19 : 44	
▶ IDE Channel 0 Master	[MAXTOR STM380215A]	Menu Level ▶
▶ IDE Channel 0 Slave	[None]	Change the day, month, year and century
▶ IDE Channel 1 Master	[None]	
▶ IDE Channel 1 Slave	[None]	
▶ IDE Channel 2 Master	[None]	
▶ IDE Channel 2 Slave	[None]	
▶ IDE Channel 3 Master	[None]	
▶ IDE Channel 3 Slave	[None]	
Drive A	[1.44M, 3.5in.]	
Video	[EGA/UGA]	
Halt On	[All , But Keyboard]	
Base Memory	640K	
Extended Memory	1047552K	
Total Memory	1048576K	

↑↓→←:Move Enter:Select +/~/PU/PD:Value F10:Save ESC:Exit F1:General Help
 F5: Previous Values F6: Fail-Safe Defaults F7: Optimized Defaults

- **Date (mm:dd:yy)**
This item sets the date you specify (usually the current date) in the format of [Month], [Date],and [Year].
- **Time (hh:mm:ss)**
This item sets the time you specify (usually the current time) in the format of [Hour], [Minute],and [Second].
- ▶ **IDE Channel 0/1/2/3 Master/Slave**
Click <Enter> key to enter its submenu:

Phoenix - AwardBIOS CMOS Setup Utility
IDE Channel 0 Master

IDE HDD Auto-Detection	[Press Enter]	Item Help
IDE Channel 0 Master Access Mode	[Auto]	Menu Level ▶
Capacity	80 GB	To auto-detect the HDD's size, head... on this channel
Cylinder	38309	
Head	16	
Precomp	0	
Landing Zone	38308	
Sector	255	

↑↓→←:Move Enter:Select +/~/PU/PD:Value F10:Save ESC:Exit F1:General Help
 F5: Previous Values F6: Fail-Safe Defaults F7: Optimized Defaults

IDE HDD Auto-Detection

This item allows you to detect the parameters of IDE drives by pressing <Enter> key. The parameters will be shown on the screen automatically.

IDE Channel 0/1/2/3 Master/Slave

When set to [Auto], the BIOS will automatically check what kind of IDE or SATA hard drive you are using. If you want to define your own drive yourself, set it to [Manual] and make sure you fully understand the meaning of the parameters. Please refer to the instruction manual provided by the device's manufacturer to get the setting right.

Access Mode

This item selects the mode to access your IDE or SATA devices. Leave this item at its default [Auto] setting to detect the access mode of your HDD automatically.

Capacity

This item displays the approximate capacity of the disk drive. Usually the size is slightly greater than the size of a formatted disk given by a disk-checking program.

Cylinder

This item configures the numbers of cylinders.

Head

This item configures the numbers of read/write heads.

Precomp

This item displays the number of cylinders at which to change the write timing.

Landing Zone

This item displays the number of cylinders specified as the landing zone for the read/write heads.

Sector

This item configures the numbers of sectors per track.

• Back to Standard CMOS Features Setup Menu**• Drive A**

This item sets the type of floppy drives installed.

• Video

This item allows you to set the video transfer card type of the monitor.

• Halt On

This item determines whether the system stops if an error is detected during system boot-up.

[All Errors]: The system-boot will stop whenever the BIOS detect a non-fatal error.

[No Errors]: The system-boot will not stop for any error detected.

[All, But Keyboard]: The system-boot will stop for all errors except a keyboard error.

[All, But Diskette]: The system-boot will stop for all errors except a diskette error.

[All, But Disk/Key]: The system-boot will stop for all errors except a diskette or keyboard error.

• Base Memory

This item displays the amount of base memory installed in the system. The value of the base memory is typically 640K for systems with 640K or more memory size installed on the mainboard.

• Extended Memory

This item displays the amount of extended memory detected during system boot-up.

• Total Memory

This item displays the total memory available in the system.

4.5.4 Advanced BIOS Features

Phoenix - AwardBIOS CMOS Setup Utility Advanced BIOS Features		
▶ CPU Feature	[Press Enter]	Item Help
▶ Removable Device Priority	[Press Enter]	Menu Level ▶
▶ Hard Disk Boot Priority	[Press Enter]	
Virus Warning	[Disabled]	
CPU L1 & L2 Cache	[Enabled]	
Quick Power On Self Test	[Enabled]	
First Boot Device	[CDROM]	
Second Boot Device	[Hard Disk]	
Third Boot Device	[LS120]	
Boot Other Device	[Enabled]	
Boot Up Floppy Seek	[Disabled]	
Boot Up NumLock Status	[On]	
Gate A20 Option	[Fast]	
Typematic Rate Setting	[Disabled]	
× Typematic Rate (Chars/Sec)	6	
× Typematic Delay (Msec)	250	
Security Option	[Setup]	
APIC Mode	[Enabled]	
MPS Version Control For OS	[1.4]	
OS Select For DRAM > 64MB	[Non-OS2]	
Delay For HDD (Secs)	[2]	
Full Screen LOGO Show	[Disabled]	
Small Logo(EPA) Show	[Disabled]	
↑↓→←:Move Enter:Select +/-/PU/PD:Value F10:Save ESC:Exit F1:General Help F5: Previous Values F6: Fail-Safe Defaults F7: Optimized Defaults		

▶ CPU Feature

Click <Enter> key to enter its submenu:

Phoenix - AwardBIOS CMOS Setup Utility CPU Feature		
Thermal Management	Thermal Monitor 1	Item Help
Limit CPUID MaxVal	[Disabled]	Menu Level ▶
Execute Disable Bit	[Enabled]	
Core Multi-Processing	[Enabled]	
Intel SpeedStep	[Disabled]	Set Limit CPUID MaxVal to 3,Should Be "Disabled" for WinXp
↑↓→←:Move Enter:Select +/-/PU/PD:Value F10:Save ESC:Exit F1:General Help F5: Previous Values F6: Fail-Safe Defaults F7: Optimized Defaults		

Limit CPUID MaxVal

When set to [Enabled], this item limits the CPUID maximum value to 3, which is usually required for older OS like Windows NT4.0.

Execute Disable Bit

This item appears only for certain processors with the Execute Disable Bit (XD bit) feature. When set to [Enabled], this item allows the processor to prevent data pages from being used by malicious software to execute code and provide memory protection.

Core Multi-Processing

Available options: [Enabled], [Disabled]

Intel SpeedStep

Available options: [Auto], [Disabled]

• Back to Advanced BIOS Features Setup Menu

- **Removable Device Priority**
This item selects the removable device booting priority.
 - **Hard Disk Boot Priority**
This item selects the hard disks booting priority. By pressing <Enter> key, you can enter its submenu where the hard disks detected can be selected for the booting sequence to boot up system.
 - **Virus Warning**
Allow you to choose the VIRUS Warning feature for IDE Hard Disk boot sector protection. If this function is enabled and someone attempt to write data into this area, BIOS will show a warning message on screen and alarm beep.
 - **CPU L1 & L2 Cache**
Enable or Disable the L1 & L2 cache which is built in the processor.
 - **Quick Power On Self Test**
When set to [Enabled], this item speeds up the Power On Self Test (POST) after powering on the system. The BIOS shorten or skip some check during the POST.
 - **First Boot Device/Second Boot Device/Third Boot Device/Boot Other Device**
Select the drive to boot first, second and third in the [First Boot Device], [Second Boot Device], and [Third Boot Device] items respectively. The BIOS will boot the operating system according to the sequence of the drive selected. Set [Boot Other Device] to [Enabled] if you wish to boot from another device other than these three items.
 - **Boot Up Floppy Seek**
During POST, BIOS will determine if the floppy disk drive installed if choose [Enable].
 - **Boot Up NumLock Status**
This item defines if the keyboard Num Lock key is active when your system is started.
 - **Gate A20 Option**
[Normal]: The A20 signal is controlled by keyboard controller or chipset hardware.
[Fast]: (default) The A20 signal is controlled by port 92 or chipset specific method.
 - **Typematic Rate Setting**
Keystrokes repeat at a rate determined by the keyboard controller. When enabled, the typematic rate and typematic delay can be selected.
 - **Typematic Rate (Chars/Sec)**
Set the number of times a second to repeat a keystroke when you hold the key down. The settings are: 6, 8, 10, 12, 15, 20, 24, and 30.
 - **Typematic Delay (Msec)**
Set the delay time after the key is held down before it begins to repeat the keystroke. The settings are 250, 500, 750, and 1000.
 - **Security Option**
This item determines when the system will prompt for password - every time the system boots or only when enters the BIOS setup.
[Setup]: The password is required only when accessing the BIOS Setup.
[System]: The password is required each time the computer boots up.
-  **Note: Don't forget your password. If you forget the password, you will have to open the computer case and clear all information in the CMOS before you can start up the system. But by doing this, you will have to reset all previously set options.**
- **APIC Mode**
This field is used to enable or disable the APIC (Advanced Programmable Interrupt Controller). Due to compliance with PC2004 design guide, the system is able to run in APIC mode. Enabling APIC mode will expand available IRQ resources for the system.
 - **MPS Version Control For OS**
This item specifies which version of MPS (Multi-Processor Specification) this mainboard will use. Leave this item at its default setting.

• **OS Select For DRAM > 64MB**

Allow OS2 to be used with >64MB or DRAM. Settings are Non-OS/2 (default) and OS2. Set to OS/2 if using more than 64MB and running OS/2.

• **Delay For HDD (Secs)**

This item allows the BIOS to support some old or special IDE devices by prolonging this delay time. A larger value will give more delay time to the device for which to initialize and to prepare for activation.

• **Full Screen LOGO Show**

This item determines to show the full screen logo when booting.

• **Small Logo(EPA) Show**

EPA Logo is the sign at the top of the screen when POST. If you don't want to show this logo, please set "Disabled".

4.5.5 Advanced Chipset Features

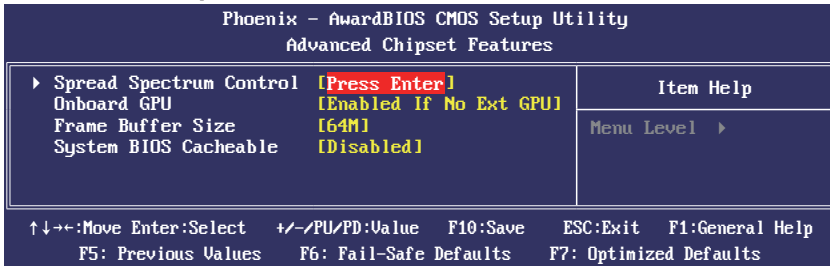

▶ **Spread Spectrum Control**

Click <Enter> key to enter its submenu:

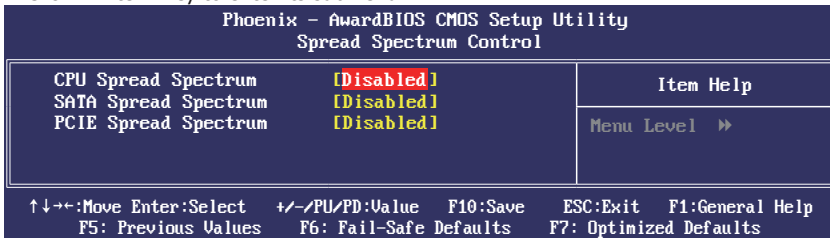

CPU Spread Spectrum

This option reduces the EMI (Electromagnetic Interference) generated by the CPU.

SATA Spread Spectrum

This item allows you to select the SATA Spread Spectrum function.

PCIE Spread Spectrum

This item allows you to select the PCIE Spread Spectrum function.

• **Back to Advanced Chipset Features Setup Menu**

• **Onboard GPU**

Available options: [Enabled If No Ext GPU], [Always Enable]

• **Frame Buffer Size**

This item allows you to choose the frame buffer size of on-chip VGA.

• **System BIOS Cacheable**

Selecting the " Enabled" option allows caching of the system BIOS ROM at F0000h-FFFFFh, which is able to improve the system performance. However, any programs that attempts to write to this memory block will cause conflicts and result in system errors.

4.5.6 Integrated Peripherals

Phoenix - AwardBIOS CMOS Setup Utility
Integrated Peripherals

	Item Help
▶ IDE Function Setup	[Press Enter]
▶ MCP Storage Config	[Press Enter]
OnChip USB	[U1.1+U2.0]
USB Memory Type	[Shadow]
USB Keyboard Support	[Disabled]
USB Mouse Support	[Disabled]
HD Audio	[Auto]
MAC Lan	[Auto]
MAC Media Interface	[Pin Strap]
Machine MAC(NU) Address	[Disabled]
x MAC(NU) Address Input	Press Enter
IDE HDD Block Mode	[Enabled]
POWER ON Function	[BUTTON ONLY]
x KB Power ON Password	Enter
x Hot Key Power ON	Ctrl-F1
Onboard FDC Controller	[Enabled]
Onboard Serial Port 1	[3F8/IRQ4]
PWRON After PWR-Fail	[Off]

↑↓←→:Move Enter:Select +/-/PU/PD:Value F10:Save ESC:Exit F1:General Help
F5: Previous Values F6: Fail-Safe Defaults F7: Optimized Defaults

▶ IDE Function Setup

Click <Enter> key to enter its submenu:

Phoenix - AwardBIOS CMOS Setup Utility
OnChip IDE Device

	Item Help
OnChip IDE Channel0	[Enabled]
Primary Master PIO	[Auto]
Primary Slave PIO	[Auto]
Primary Master UDMA	[Auto]
Primary Slave UDMA	[Auto]
IDE DMA transfer access	[Enabled]
Serial-ATA Controller	[Enabled]
IDE Prefetch Mode	[Enabled]

↑↓←→:Move Enter:Select +/-/PU/PD:Value F10:Save ESC:Exit F1:General Help
F5: Previous Values F6: Fail-Safe Defaults F7: Optimized Defaults

OnChip IDE Channel 0

The mainboard chipset contains a PCI IDE interface with support for two IDE channels. Select "Enabled" to activate the first and/or second IDE interface. Select "Disabled" to deactivate an interface if you are going to install a primary and/or secondary add-in IDE interface.

Primary Master/Slave PIO

Each IDE channel supports a master device and a slave device. These four items let you assign the kind of PIO (Programmed Input/Output) were used by the IDE devices. Choose Auto to let the system auto detect which PIO mode is best, or select a PIO mode from 0-4.

Primary Master/Slave UDMA

Each IDE channel supports a master device and a slave device. This mainboard supports UltraDMA technology, which provides faster access to IDE devices. If you install a device that supports UltraDMA, change the appropriate item on this list to Auto. You may have to install the UltraDMA driver supplied with this mainboard in order to use an UltraDMA device.

IDE DMA transfer access

This item allows you to enable the transfer access of the IDE DMA then burst onto the PCI bus and nonburstable transactions do not.

Serial-ATA Controller

Available options: [Disabled] [Enabled]

IDE Prefetch Mode

The "onboard" IDE drive interfaces supports IDE prefetch function for faster drive access. If the interface on your drive does not support prefetching, or if you install a primary and/or secondary add-in IDE interface, set this option to "Disabled".

- **Back to Integrated Peripherals Setup Menu**

- ▶ **MCP Storage Config**

Click <Enter> key to enter its submenu:

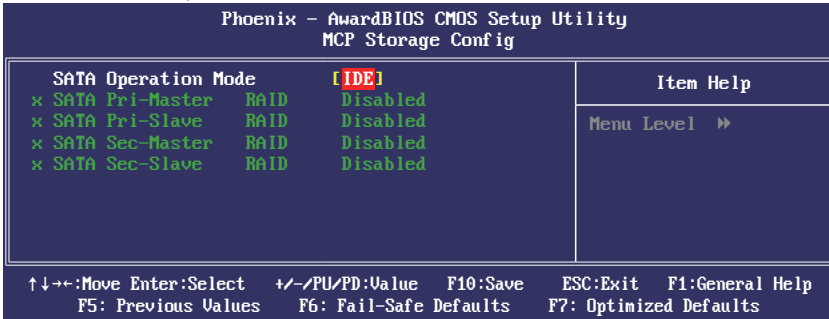

SATA Operation Mode

This option allows you to select SATA function.

SATA 0 Pri-/Sec- Master/Slave RAID

This option allows you to enable or disable SATA Primary/Secondary RAID.

This is configurable only when "SATA Operation Mode" is set to "RAID".

- **Back to Integrated Peripherals Setup Menu**

- **OnChip USB**

This option allows you to disabled the USB function or select the mode of USB.

- **USB Memory Type**

Available options: [Base Memory (640K)] [Shadow].

- **USB Keyboard Support**

This item allows you to select [BIOS] for using USB keyboard in DOS environment, or [OS] in OS environment.

- **USB Mouse Support**

This item allows you to select [BIOS] for using USB mouse in DOS environment, or [OS] in OS environment.

- **HD Audio**

Available options: [Auto] [Disabled].

- **MAC Lan**

Available options: [Disabled] [Enabled].

- **MAC Media Interface**

Available options: [Pin Strap] [MII] [RGMII].

- **Machine MAC(NV) Address**

Available options: [Disabled], [Enabled].

- **MAC(NV) Address Input**

This is configuration only when "Machine MAC(NV) Address" is set to "Enabled".

- **IDE HDD Block Mode**

Enable this field if your IDE hard drive supports block mode. Block mode enables BIOS to automatically detect the optimal number of block read and writes per sector that the drive can support. It also improves the speed of access to IDE devices.

- **POWER ON Function**

This item selects the way you want your system to power on.

[Password]: Use a password to power on the system, select this option then press <Enter>. Enter your password. You can enter up to 5 characters. Type in exactly the same password to confirm, and then press <Enter>.

[Hot KEY]: Use any of the function keys between <Ctrl+F1> to <Ctrl+F12> to power on the system.

[Mouse Left]: Double click the mouse left button to power on the system.

[Mouse Right]: Double click the mouse right button to power on the system.

[Any KEY]: Use any keyboard keys to power on the system.

[Button Only]: Use only the power button to power on the system.

[Keyboard 98]: Use the power-on button on the "Keyboard 98" compatible keyboard to power on the system.

- **KB Power ON Password**

If you select [Password], this function will be activation.

Press 'Enter', and input your password (1-5 characters), then press 'Enter' again.

- **Hot Key Power ON**

If you select [Hot Key], this function will be activation.

Available options: Ctr-F1~F12

- **Onboard FDC Controller**

This option enables or disables the onboard FDC controller.

- **Onboard Serial Port 1**

This item determines which I/O addresses the onboard Serial Port controller will access.

[Auto]: The system automatically select an I/O address for the onboard Serial Port.

[3F8/IRQ4, 2F8/IRQ3, 3E8/IRQ4, 2E8/IRQ3]: Allow you to manually select an I/O address for the onboard Serial Port.

[Disabled]: Disables the onboard Serial Port.

- **PWRON after PWR-Fail**

This item enables your computer to automatically restart or return to its last operating status after power returns from a power failure.

4.5.7 Power Management Setup

Phoenix - AwardBIOS CMOS Setup Utility		Item Help
Power Management Setup		
ACPI Function	[Enabled]	
ACPI Suspend Type	[S1(POS)]	
Power Management	[User Define]	Menu Level →
Video Off Method	[DPMS Support]	
HDD Power Down	[Disabled]	
Video Off In Suspend	[Disabled]	
Soft-Off by PBTN	[Instand-Off]	
WOL(PME#) From Soft-Off	[Disabled]	
WOR(RI#) From Soft-Off	[Disabled]	
Power-On by Alarm	[Disabled]	
× Day of Month Alarm	0	
× Time (hh:mm:ss) Alarm	0 : 0 : 0	
HPET Support	[Enabled]	

↑↓←→: Move Enter: Select +/~/PU/PD: Value F10: Save ESC: Exit F1: General Help
 F5: Previous Values F6: Fail-Safe Defaults F7: Optimized Defaults

- **ACPI Function**

This item allows you to Enabled/Disabled the Advanced Configuration and Power Management (ACPI).

- **ACPI Suspend Type**

This item allows you to select ACPI Suspend Type.

- **Power Management**

This option is for choose ACPI mode (or grade) etc.

Min Saving	If system activity is not detected for 1 hour, all devices except CPU will be shut off. If this item is selected, Doze/Standby/Suspend Mode are not available.
Max Saving	If system activity is not detected for 10 seconds, all devices except CPU will be shut off.

- **Video off Method**

V/H SYNC+Blank	This selection will cause the system to turn off the vertical and horizontal synchronization ports and write blanks to the video buffer.
Blank Screen	This option only writes blanks to the video buffer.
DPMS Support	Initial display power management signaling.(default)

- **HDD Power Down**

If HDD activity is not detected for the length of time specified in this field, the HDD will be shut off.

- **HDD Down In Suspend**

This option allows you to enabled or disabled the HDD power down function in suspend mode.

- **Soft-Off by PBTn**

Pressing the power button for more than 4 seconds forces the system to enter the Soft-Off state.

- **WOL (PME#) From Soft-Off**

When enabled, NV LAN activity awakens the system from soft-off state.

- **WOR(RI#) From Soft-Off**

This item allows you to enable or disable Wake On Ring from Soft-Off function.

- **Power-On by Alarm**

The field is used to enable or disable the feature of booting up the system on a scheduled time/date.

- **Day of Month Alarm**

[0]: This option power-on the system everyday according to the time set in the "Time (hh:mm:ss) Alarm" item.

[1-31]: This option selects a date you would like the system to power-on. The system will power-on on the date set, and the time set in the "Time (hh:mm:ss) Alarm" item.

- **Time (hh:mm:ss) Alarm**

This item sets the time you would like the system to power-on.

- **HPET Support**

Available options: [Disabled], [Enabled].

4.5.8 PnP/PCI Configuration

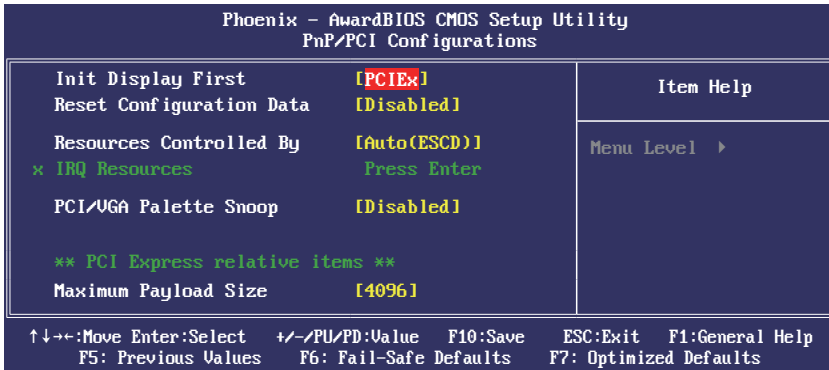

- Init Display First**
 This setting specifies which graphics card is your primary graphics adapter. We suggest you to keep the default setting.
- Reset configuration data**
 Usually you'd better keep this setting [Disabled].
- Resource controlled by**
 The plug and play bios from Award can configure all the booting devices and plug and play devices automatically.
- IRQ Resources**
 Press <Enter> to enter the sub-menu and the following screen appears. When "Resources Controlled By" sets to [Manual], this field is adjustable.
 IRQ-5 assigned to PCI Device
 IRQ-7 assigned to PCI Device
 IRQ-9 assigned to PCI Device
 IRQ-10 assigned to PCI Device
 IRQ-11 assigned to PCI Device
 IRQ-14 assigned to PCI Device
 IRQ-15 assigned to PCI Device
- PCI/VGA Palette Snoop**
 If this option sets to [Enabled], different VGA devices which work in different bus will manage the data from CPU with different palettes.
 NOTE: This option can fix some issue that the VGA card is not standard .We suggest you to keep the default setting.
- Maximum Payload Size**
 This setting specifies the maximum TLP payload size for the PCI Express devices. The unit is byte.

4.5.9 PC Health Status

Phoenix - AwardBIOS CMOS Setup Utility
PC Health Status

	Item Help
Post Sensor [Disabled]	
SYS TEMP 28°C / 82°F	
CPU TEMP 30°C / 86°F	
SYS FAN2 0 RPM	Menu Level ▶
CPU FAN 4218 RPM	
SYS FAN1 0 RPM	Show PC Health On the Post Screen.
CPU Voltage 1.39 V	
Chipset Voltage 1.37 V	
+ 5 V Voltage 5.06 V	
+12 V Voltage 12.29 V	
DRAM Voltage 1.97 V	
VBAT 3.29 V	
+3.3V Voltage 3.22 V	
Smart Fan control by Thermal Cruise way	
Target Temperatur(30-60°C) [12]	
The Mini PWM out(00-255) [100]	

↑↓←→:Move Enter:Select +/-/PU/PD:Value F10:Save ESC:Exit F1:General Help
F5: Previous Values F6: Fail-Safe Defaults F7: Optimized Defaults

- **Post Sensor**
Show the system status when post.
- **All Voltages, Fans Speed and Thermal Monitoring**
These unchangeable items list the current status of the CPU and environment temperatures, fan speeds, and system power voltage.
- **Target Temperatur(30-60°C)**
This item sets the temperature mark for the "Smart Fan" function to take effect.
- **The Mini PWM out(00-255)**
According to PWM out configuration adjustable CPU Fan speed.

4.5.10 Frequency/Voltage Control

Phoenix - AwardBIOS CMOS Setup Utility
Frequency/Voltage Control

	Item Help
▶ FSB & Memory Config [Press Enter]	
BIOS Write Protect [Disabled]	
Onboard Lan Control [Enabled]	Menu Level ▶
Lan BootROM Control [Disabled]	
*** Voltage Control ***	
DRAM Voltage Control [Default]	
CPU Voltage Control [Default]	
Chipset Voltage Control [Default]	
CPUFSB Voltage Control [Default]	

↑↓←→:Move Enter:Select +/-/PU/PD:Value F10:Save ESC:Exit F1:General Help
F5: Previous Values F6: Fail-Safe Defaults F7: Optimized Defaults

- ▶ **FSB & Memory Config**
Click <Enter> key to enter its submenu:
You may enter the submenu to adjust the CPU FSB and memory config.

Phoenix - AwardBIOS CMOS Setup Utility FSB & Memory Config			
Parameters	Setting	Current Value	Item Help
Current CPU Freq, MHz	2666.7	2666.7	Menu Level ▶
FSB Clock, MHz	533.3	533.3	
CPU Multiplier	20X	20X	
FSB - Memory Clock Mode	Auto		
× FSB - Memory Ratio	Auto		
× FSB (QDR), MHz	Auto	533.3	
Actual FSB (QDR), MHz	533.3		
× MEM (DDR), MHz	Auto		
Actual MEM (DDR), MHz	666.7	666.7	
▶ Memory Timing Setting	[Press Enter]		

↑↓←→:Move Enter:Select +/~/PU/PD:Value F10:Save ESC:Exit F1:General Help
 F5: Previous Values F6: Fail-Safe Defaults F7: Optimized Defaults

▶ **Memory Timing Setting**

Click <Enter> key to enter its submenu:

Use this menu to set optimal timings or to manually enter timings.

Phoenix - AwardBIOS CMOS Setup Utility Memory Timing Setting			
Parameters	Setting	Current Value	Item Help
Memory Timing Setting	Optimal		Menu Level ▶
× tCL (CAS Latency)	Auto(0)	5	
× tRCD	Auto(0)	5	
× tRP	Auto(0)	5	
× tRAS	Auto(0)	15	
× Command Per Clock (CMD)	Auto(0T)	2T	
** Advanced Memory Settings **			
× tRRD	Auto(0)	3	
× tRC	Auto(0)	20	
× tWR	Auto(0)	5	
× tWTR	Auto(0)	11	
× tREF	Auto	7.8uS	

↑↓←→:Move Enter:Select +/~/PU/PD:Value F10:Save ESC:Exit F1:General Help
 F5: Previous Values F6: Fail-Safe Defaults F7: Optimized Defaults

- **Back to Frequency/Voltage Control Setup Menu**
- **BIOS Write Protect**
Available options: [Disabled], [Enabled].
- **Onboard Lan Control**
Available options: [Disabled], [Enabled].
- **Lan BootROM Control**
Available options: [Disabled], [Enabled].
- **DRAM Voltage Control**
This option is for setting the voltage of DIMM.
- **CPU Voltage Control**
This option is for setting the voltage of CPU.
- **Chipset Voltage Control**
This option is for setting the voltage of Chipset.
- **CPUFBS Voltage Control**
This option is for setting the voltage of CPUFSB.

4.5.11 Load Fail-Safe Defaults

This option opens a dialog box that lets you install fail-safe defaults for all appropriate items in the Setup Utility: Press <Y> and the <Enter> to install the defaults. Press <N> and then <Enter> to not install the defaults. The fail-safe defaults place no great demand on the system and are generally stable. If your system is not functioning correctly, try installing the fail-safe defaults as a first step in getting your system working properly again. If you only want to install fail-safe defaults for a specific option, select and display that option, and then press <F6>.



4.5.12 Load Optimized Defaults

This option opens a dialog box that let you install optimized defaults for all appropriate items in the Setup Utility. Press <Y> and then <Enter> to install the defaults. Press <N> and then <Enter> to not install the defaults. The optimized defaults place demand on the system that may be greater than the performance level of the components, such as the CPU and the memory. You can cause fatal errors or instability if you install the optimized defaults when your hardware does not support them. If you only want to install setup defaults for a specific option, select and display that option, and then press <F7>.



4.5.13 Set Supervisor/User Password

When this function is selected, the following message appears at the center of the screen to assist you in creating a password.



Type the password, up to eight characters, and press <Enter>. The password typed now will clear any previously entered password from CMOS memory. You will be asked to confirm the password. Type the password again and press <Enter>.



You may also press <Esc> to abort the selection.

To disable password, just press <Enter> when you are prompted to enter password. A message will confirm the password being disabled. Once the password is disabled, the system will boot and you can enter BIOS Setup freely.



```
PASSWORD DISABLED !!!  
Press any key to continue...
```

4.5.14 Save & Exit Setup

Highlight this item and press <Enter> to save the changes that you have made in the Setup Utility and exit the Setup Utility. When the Save and Exit dialog box appears, press <Y> to save and exit, or press <N> to return to the main menu.



```
SAVE to CMOS and EXIT (Y/N)? Y
```

4.5.15 Exit Without Saving

Highlight this item and press <Enter> to discard any changes that you have made in the Setup Utility and exit the Setup Utility. When the Exit Without Saving dialog box appears, press <Y> to discard changes and exit, or press <N> to return to the main menu.



```
Quit Without Saving (Y/N)? Y
```

APPENDIX 1

POST Codes

NOTE: EISA POST codes are typically output to port address 300h.

ISA POST codes are output to port address 80h.

Code

(hex) Name	Description
C0 Turn Off Chipset Cache	OEM Specific-Cache control
1 Processor Test 1	Processor Status (1FLAGS) Verification. Tests the following processor status flags: carry, zero, sign, overflow, The BIOS sets each flag, verifies they are set, then turns each flag off and verifies it is off.
2 Processor Test 2	Read/Write/Verify all CPU registers except SS, SP, and BP with data pattern FF and 00.
3 Initialize Chips	Disable NMI, PIE, AIE, UEI, SQWV Disable video, parity checking, DMA Reset math coprocessor. Clear all page registers, CMOS shutdown byte. Initialize timer 0, 1, and 2, including set EISA timer to a known state. Initialize DMA controllers 0 and 1. Initialize interrupt controllers 0 and 1. Initialize EISA extended registers.
4 Test Memory Refresh Toggle	RAM must be periodically refreshed to keep the memory from decaying. This function ensures that the memory refresh function is working properly.
5 Blank video, Initialize keyboard	Keyboard controller initialization.
6 Reserved	
7 Test CMOS Interface and Battery Status	Verifies CMOS is working correctly, detects bad battery.
BE Chipset Default Initialization	Program chipset registers with power on BIOS defaults.
C1 Memory presence test	OEM Specific-Test to size on-board memory.
C5 Early Shadow	OEM Specific-Early Shadow enable for fast boot.
C6 Cache presence test	External cache size detection.
8 Setup low memory	Early chip set initialization. Memory presence test OEM chip set routines. Clear low 64K of memory. Test first 64K memory.

9	Early Cache Initialization	Cyrix CPU initialization. Cache initialization.
A	Setup Interrupt Vector Table	Initialize first 120 interrupt vectors with SPURIOUS_INT_HDLR and initialize INT 00h-1Fh according to INT_TBL.
B	Test CMOS RAM Checksum	Test CMOS RAM Checksum, if bad, or insert key pressed, load defaults.
C	Initialize keyboard (optional)	Detect type of keyboard controller. Set NUM_LOCK status.
D	Initialize Video Interface	Detect CPU clock. Read CMOS location 14h to find out type of video in use. Detect and Initialize Video Adapter.
E	Test Video Memory	Test video memory, write sign-on message to screen. Setup shadow RAM - Enable shadow according to Setup.
F	Test DMA Controller 0	BIOS checksum test. Keyboard detect and initialization.
10	Test DMA Controller 1	
11	Test DMA Page Registers	Test DMA Page Registers.
12-13	Reserved	
14	Test Timer Counter 2	Test 8254 Timer 0 Counter 2.
15	Test 8259-1 Mask Bits	Verify 8259 Channel 1 masked interrupts by alternately turning off and on the interrupt lines.
16	Test 8259-2 Mask Bits	Verify 8259 Channel 2 masked interrupts by alternately turning off and on the interrupt lines.
17	Test Stuck 8259's Interrupt Bits	Turn off interrupts then verify no interrupt mask register is on.
18	Test 8259 Interrupt Functionality	Force an interrupt and verify the interrupt occurred.
19	Test Stuck NMI Bits (Parity/IO Check)	Verify NMI can be cleared.
1A		Display CPU clock
1B-1E	Reserved	
1F	Set EISA Mode	If EISA non-volatile memory checksum is good, execute EISA initialization. If not, execute ISA tests and clear EISA mode flag. Test EISA Configuration Memory Integrity (checksum & communication interface).
20	Enable Slot 0	Initialize slot 0 (System Board).

21-2F	Enable Slots 1-15	Initialize slots 1 through 15.
30	Size Base and Extended Memory	Size base memory from 256K to 640K and extended memory above 1MB.
31	Test Base and Extended Memory	Test base memory from 256K to 640K and extended memory above 1MB using various patterns. NOTE: This test is skipped in EISA mode and can be skipped with ESC key in ISA mode.
32	Test EISA Extended Memory	If EISA Mode flag is set then test EISA memory found in slots initialization. NOTE: This test is skipped in ISA mode and can be skipped with ESC key in EISA mode.
33-3B	Reserved	
3C	Setup Enabled	
3D	Initialize & Install Mouse	Detect if mouse is present, initialize mouse, install interrupt vectors.
3E	Setup Cache Controller	Initialize cache controller.
3F	Reserved	
BF	Chipset Initialization	Program chipset registers with Setup values.
40		Display virus protect disable or enable.
41	Initialize Floppy Drive & Controller	Initialize floppy disk drive controller and any drives.
42	Initialize Hard Drive & Controller	initialize hard drive controller and any drives.
43	Detect & Initialize Serial/Parallel Ports	Initialize any serial and parallel ports (also game port).
44	Reserved	
45	Detect & Initialize Math Coprocessor	Initialize math coprocessor.
46	Reserved	
47	Reserved	
48-4D	Reserved	

4E	Manufacturing POST Loop or Display Messages	Reboot if Manufacturing POST Loop pin is set. Otherwise display any messages (i.e., any non-fatal errors that were detected during POST) and enter Setup.
4F	Security Check	Ask password security (optional).
50	Write CMOS	Write all CMOS values back to RAM and clear screen.
51	Pre-boot Enable	Enable parity checker. Enable NMI, Enable cache before boot.
52	Initialize Option ROMs	Initialize any option ROMs present from C8000h to EFFFFh. NOTE: When FSCAN option is enabled, ROMs initialize from C8000h to F7FFFh.
53	Initialize Time Value	Initialize time value in 40h: BIOS area.
60	Setup Virus Protect	Setup virus protect according to Setup.
61	Set Boot Speed	Set system speed for boot
62	Setup NumLock	Setup NumLock status according to Setup.
63	Boot Attempt	Set low stack Boot via INT 19h.
B0	Spurious	If interrupt occurs in protected mode.
B1	Unclaimed NMI	If unmasked NMI occurs, display. Press F1 to disable NMI, F2 reboot.
E1-EF	Setup Pages	E1- Page 1, E2 - Page 2, etc.
FF	Boot	